

NP12-7.2Ah 12V7.2Ah

Specifications

Nominal Voltage		12V
Rated capacity (20 hour rate)		7.2Ah
Dimensions	Length	151±1.5mm(5.94inch)
	Width	65±1mm(2.56inch)
	Height	94±1mm(3.70inch)
	Total Height	100±1mm(3.94inch)
Approx. Weight		2.2kg(4.85lbs)±4%



Outer dimensions (mm)

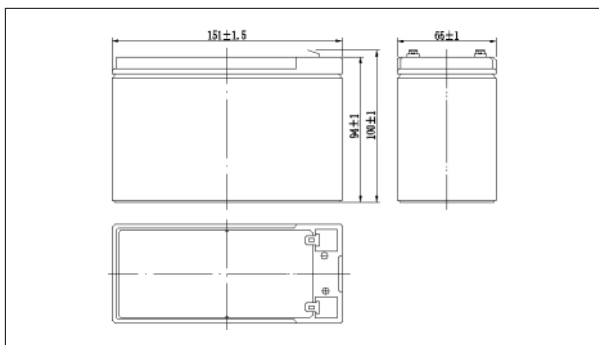

Terminal Type (mm)

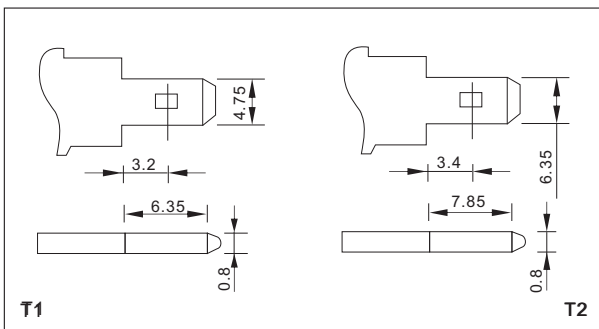

Characteristics

Capacity (25°C)	20HR(10.5V)	7.2Ah
	10HR(10.5V)	6.7Ah
	1HR(9.60V)	4.4Ah
Terminal type		T1/T2
Internal resistance (Fully charged, 25°C)		Approx. 30m Ω
Capacity affected by temperature (20HR)	40°C	102%
	25°C	100%
	0°C	85%
	-15°C	65%
Self-discharge (25°C)	3 months	Remaining Capacity:91%
	6 months	Remaining Capacity:82%
	12 months	Remaining Capacity:65%
Nominal operating temperature		25°C ±3°C(77°F ±5°F)
Operating temperature range	Discharge	-15°C~50°C(5°F~122°F)
	Charge	-10°C~50°C(14°F~122°F)
	Storage	-20°C~50°C(-4°F~122°F)
Float charging voltage(25°C)		13.50 to 13.80V Temperature compensation: -18mV/°C
Cyclic charging voltage(25°C)		14.50 to 15.00V Temperature compensation: -30mV/°C
Maximum charging current		2.16A
Maximum discharge current		108A(5 sec.)
Designed floating life(20°C)		5 years

Construction

Component	Positive plate	Negative plate	Container	Cover	Separator	Electrolyte	Safety valve	Terminal
Raw material	Lead dioxide	Lead	ABS	ABS	AGM	Sulfuric acid	Rubber	Copper

Constant Current Discharge Characteristics Unit:A(25°C,77°F)

F.V/Time	5min	10min	15min	30min	60min	2h	3h	4h	5h	10h	20h
9.60V	27.5	17.4	13.6	7.67	4.72	2.58	1.78	1.48	1.26	0.68	0.37
9.90V	26.7	16.9	13.3	7.51	4.65	2.56	1.77	1.47	1.25	0.68	0.36
10.2V	25.6	16.2	12.8	7.28	4.53	2.54	1.76	1.46	1.24	0.68	0.36
10.5V	24.5	15.5	12.4	7.11	4.44	2.50	1.75	1.45	1.23	0.67	0.36
10.8V	23.1	14.6	11.7	6.85	4.30	2.44	1.70	1.40	1.19	0.66	0.35

Constant Power Discharge Characteristics Unit:W(25°C,77°F)

F.V/Time	5min	10min	15min	30min	60min	2h	3h	4h	5h	10h	20h
9.60V	307	197	155	87.9	54.6	30.2	21.2	17.6	15.0	8.18	4.38
9.90V	298	191	151	86.1	53.8	30.0	21.1	17.5	14.9	8.15	4.37
10.2V	285	183	146	83.5	52.4	29.7	20.9	17.4	14.8	8.11	4.35
10.5V	273	175	141	81.5	51.4	29.3	20.8	17.2	14.7	8.06	4.32
10.8V	258	165	133	78.5	49.8	28.5	20.2	16.7	14.3	7.90	4.23

Note: The above characteristics data can be obtained within three charge or discharge cycles.

NP12-7.2Ah 12V7.2Ah

● **Discharge characteristics(25°C)**

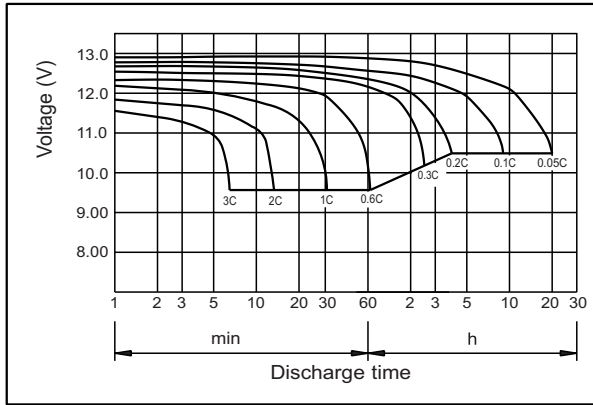

● **Charging characteristics (25°C)**

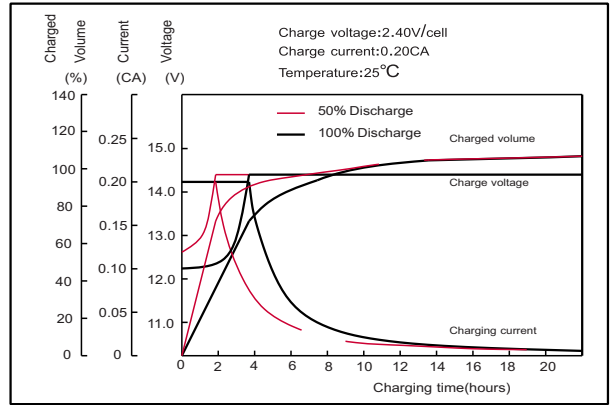

● **Effect of temperature on capacity**

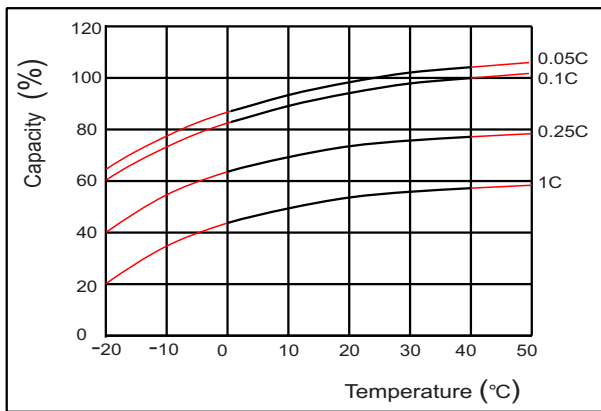

● **Self-discharge characteristics**

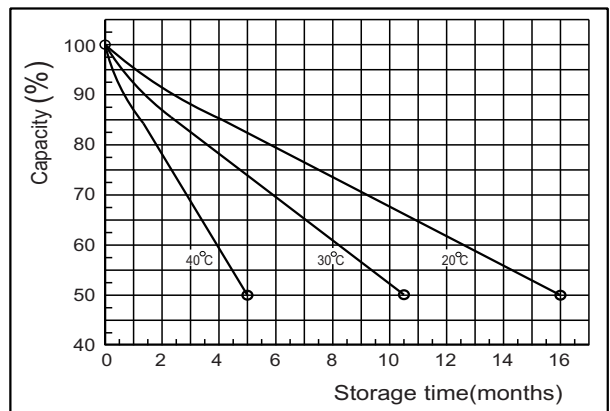

● **Floating life on temperature**

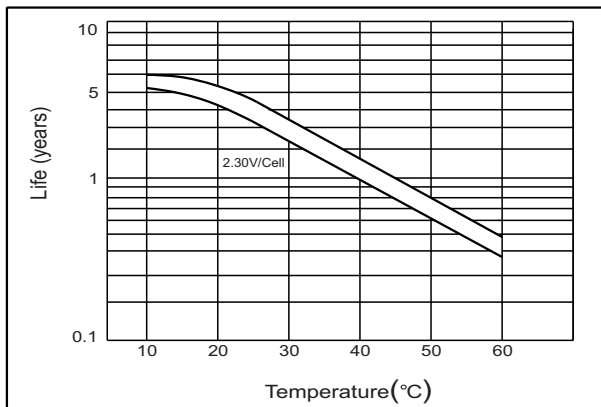

● **Cycle life on D.O.D(25°C)**

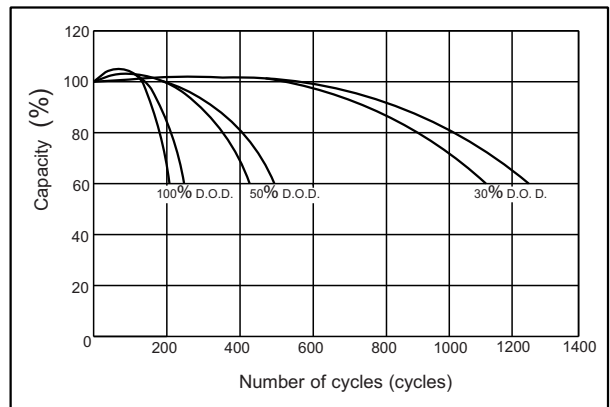

● **The relationship for OCV and Capacity (25°C)**

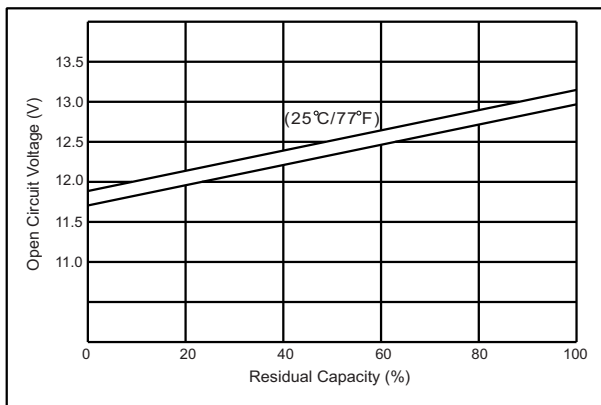

● **The relationship for Charging voltage and Temperature**

