

Powered by



HR 1251W ▶ 12V 51W

HR 1251W is specially designed for high efficient discharge application. Its characteristics are high energy density, small footprint and high discharge efficiency. It can be used for more than 260 cycles at 100% discharge in cycle service, up to 5 years in standby service.



► Specification

Cells Per Unit	6
Voltage Per Unit	12
Capacity	51W @ 15min-rate to 1.67V per cell @25 °C (77°F)
Weight	Approx. 3.72 kg (8.2 lbs)
Maximum Discharge Current	150/180 A(5sec)
Internal Resistance	Approx. 13 mΩ
Operating Temperature Range	Discharge: -15°C~50°C (5°F~122°F) Charge: -15 °C~40°C (5°F~104°F) Storage: -15°C~40°C (5°F~104°F)
Nominal Operating Temperature Range	25°C±3°C (77°F±5°F)
Float Charging Voltage	13.5 to 13.8 VDC/unit Average at 25°C (77°F)
Recommended Maximum Charging Current Limit	5.1A
Equalization and Cycle Service	14.4 to 15.0 VDC/unit Average at 25°C (77°F)
Self Discharge	CSB Batteries can be stored for more than 6 months at 25°C (77°F). Please charge batteries before using. For higher temperatures the time interval will be shorter.
Terminal	F1/F2-Faston Tab187/250
Container Material	ABS(UL 94-HB/File E50263)*Flammability resistance of (UL 94-V0/File E88637) can be available upon request.



MH14533(N)



ISO9001
No.:041005117



ISO 14001
NO.UM 1-12-0045

CSB-manufactured VRLA batteries are UL-recognized components under UL924 and UL1989.

CSB is also certified by ISO 9001 and ISO 14001.

► Dimensions :

Unit: mm (inch)

Overall Height (H)	Container height (h)	Length (L)	Width (W)
100±1 (3.94±0.04)	94±1 (3.7±0.04)	151±2 (5.94±0.08)	98±1 (3.85±0.04)

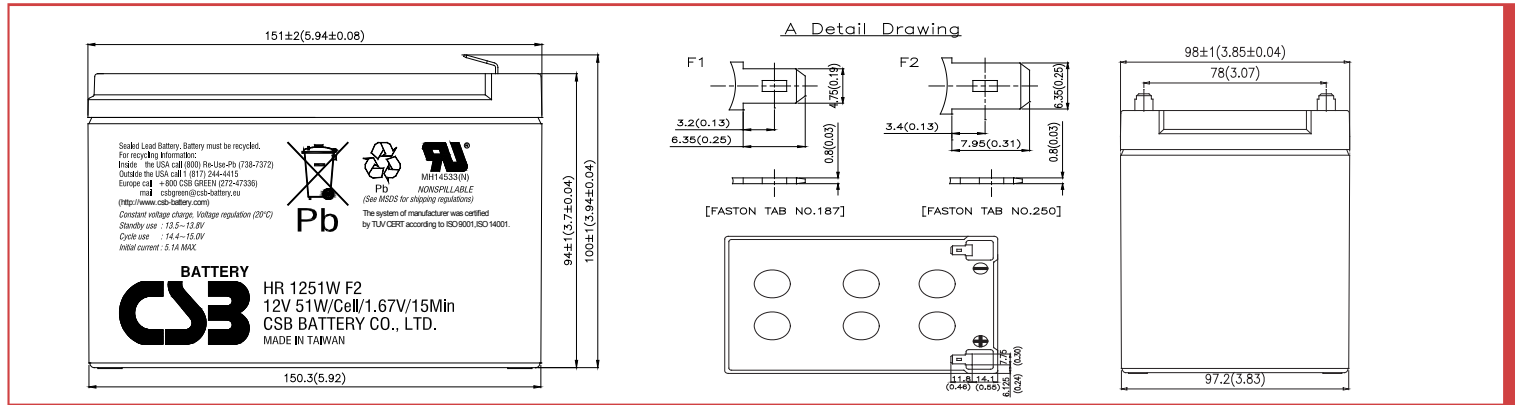

Constant Current Discharge Characteristics Unit:A (25°C, 77°F)

F.V/Time	2MIN	4MIN	6MIN	8MIN	10MIN	15MIN	20MIN	30MIN	60MIN	90MIN
1.60V	85.8	64.0	50.8	43.0	36.8	27.1	21.4	15.4	8.33	6.65
1.67V	82.4	61.6	49.2	41.8	35.8	26.7	20.9	15.3	8.29	6.61
1.70V	80.5	60.5	48.0	41.2	35.2	26.4	20.7	15.2	8.28	6.58
1.75V	77.2	57.9	46.4	39.9	34.3	25.7	20.3	15.1	8.24	6.52
1.80V	72.9	54.8	44.6	38.3	32.9	24.8	19.9	14.9	8.20	6.44
1.85V	68.6	51.6	42.7	36.5	31.6	23.9	19.6	14.7	8.16	6.36

Constant Power Discharge Characteristics Unit:W (25°C, 77°F)

F.V/Time	2MIN	4MIN	6MIN	8MIN	10MIN	15MIN	20MIN	30MIN	60MIN	90MIN
1.60V	1,030	768	607	511	441	325	257	185	100	79.8
1.67V	990	742	585	500	430	320	251	184	99.6	79.4
1.70V	969	726	573	494	422	317	249	183	99.3	79.0
1.75V	927	695	552	479	408	310	244	181	98.9	78.3
1.80V	875	657	532	460	393	300	239	179	98.4	77.3
1.85V	824	619	513	441	379	290	235	177	97.9	76.4

Trickle (or Float) Service Life

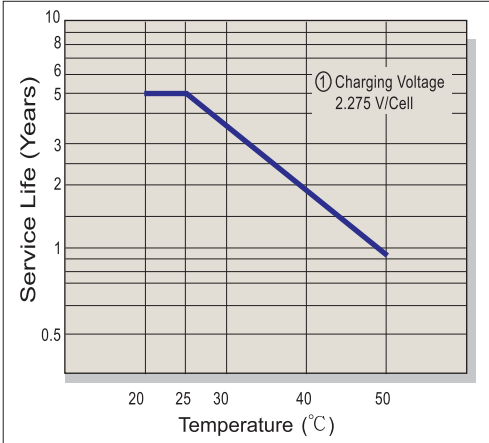

Capacity Retention Characteristic

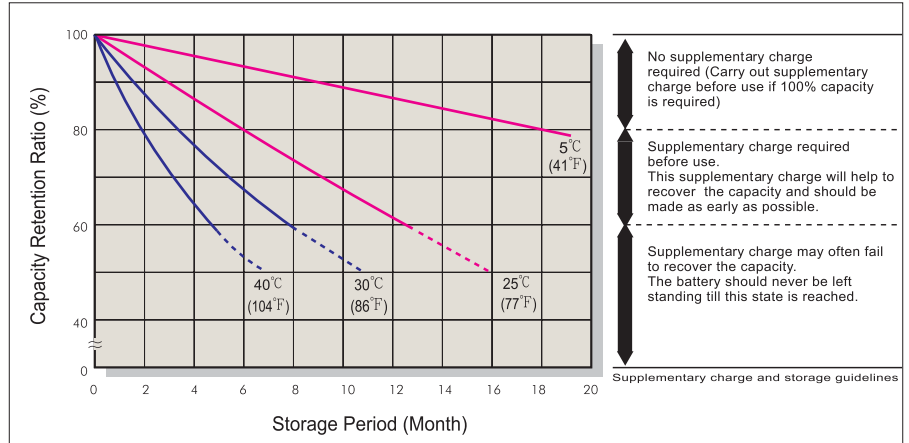

Battery Voltage and Charge Time for Standby Use

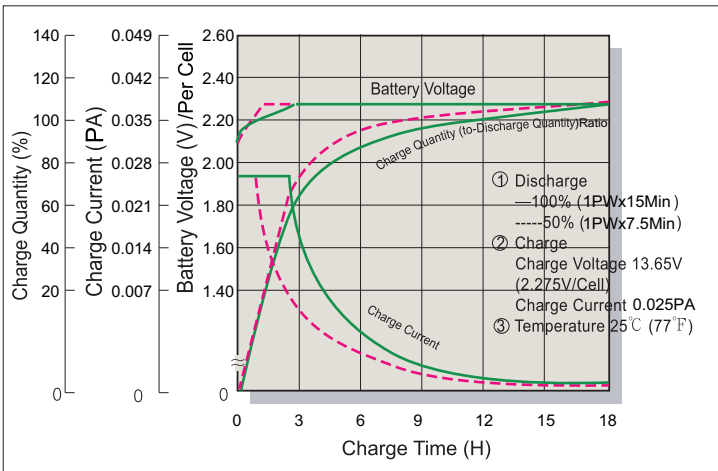

Cycle Service Life

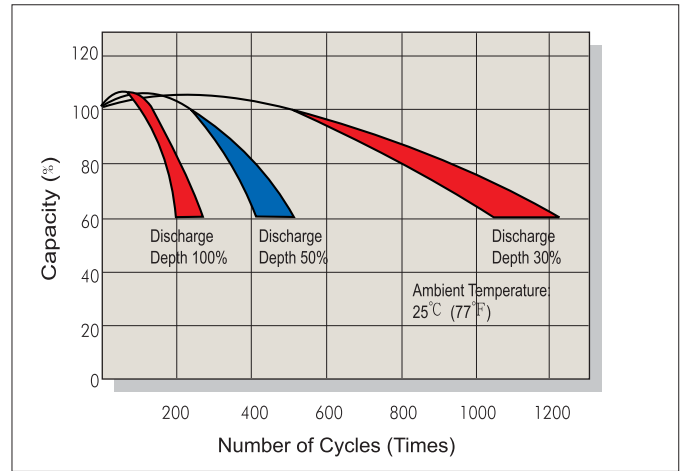

Battery Voltage and Charge Time for Cycle Use

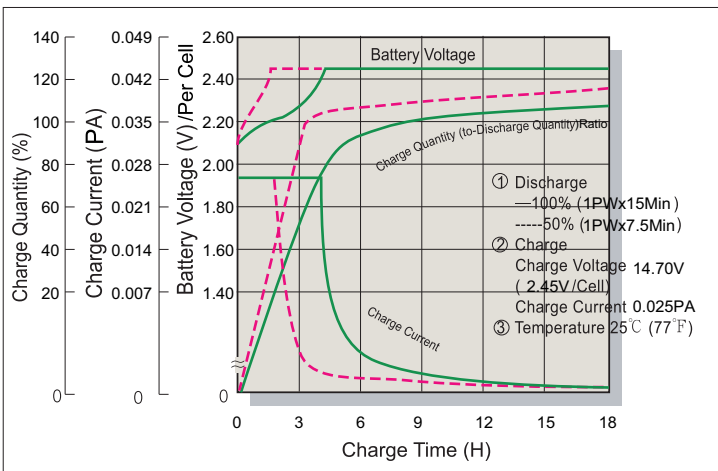

Terminal Voltage (V) and Discharge Time

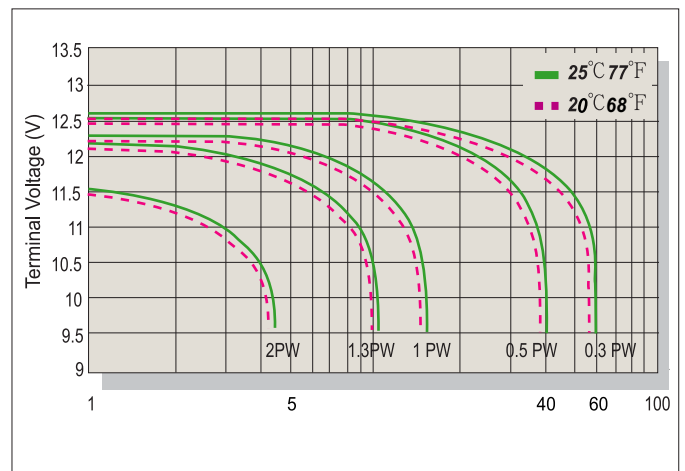

Charging Procedures

Application	Charge Voltage(V/Cell)			Max.Charge Current
	Temperature	Set Point	Allowable Range	
Cycle Use	25°C (77°F)	2.45	2.40~2.50	0.1PA
Standby	25°C (77°F)	2.275	2.25~2.30	

Discharge Current VS. Discharge Voltage

Final Discharge Voltage V/Cell	1.75	1.70	1.60	1.30
Discharge Power(W)	0.1P>(W)	0.1P≤(W)<0.25P	0.25P≤(W)<1.0P	(W)≥1.0P

Sales Office URL: WWW.CSB-BATTERY.COM

GLOBAL HQ
CSB BATTERY CO., LTD. (TAIWAN)
 Tel : +886-2-2555-5600
 Fax : +886-2-2555-3300
 mail : service@csb-battery.com.tw

BEIJING OFFICE. (CHINA)
CSB BATTERY TECHNOLOGIES (BEIJING) CO., LTD.
 Tel : +86-10-59621300/1301/1302/1303
 Fax : +86-10-59621304
 mail : chinasl@csb-battery.com

AMERICA HQ
CSB BATTERY TECHNOLOGIES INC. (U.S.A)
 Tel : +1-817-244-7777/1-(800)3-CSB-USA(272872)
 Fax : +1-817-244-4445
 mail : csb@csb-battery.com

SHANGHAI OFFICE. (CHINA)
CSB BATTERY LOGISTIC (SHANGHAI) CO., LTD.
 Tel : +86-21-5046-1622/5046-0833
 Fax : +86-21-5064-3314
 mail : chinasl@csb-battery.com

EUROPE HQ
CSB Battery Europe BV.
 Tel : +31(0)-180-418-140
 Fax : +886-2-2555-3300
 mail : eurosales@csb-battery.eu

SHENZHEN OFFICE. (CHINA)
CSB BATTERY LOGISTIC (SHANGHAI) CO., LTD.
 Tel : +86-755-8831-6488/6396/6356
 Fax : +86-755-8831-6548
 mail : she@csb-battery.com.cn